

Explosion-Protected Light Fitting with tapered sheet steel body Series e181/182..

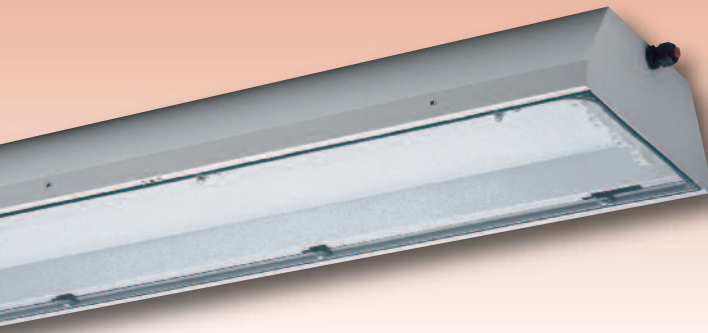

Applications:

Hazardous areas of Zones 1, 21 and 2, 22, e.g. paint shops, paint-spray lines and spray booths.

Design:

Housing: Sheet steel, powder coated in white (RAL 9016); stainless steel on request.

Glass cover: Impact resistant safety glass pane, frameless / hinged.

Reflector: Hinged; white painted sheet steel; detachable.

Central locking system: Operated by a 5mm allen key, hinges on the opposite side.

Isolating switch: Switching off all poles when light fitting is opened.

Optical indicator showing the actual po-

sition of the switch.

Wiring: Double channel ballast with "end-of-life switching-off system".

Connection terminals: Standard L1+N+PE, up to 6,0mm².

Cable entries: 3 entries M25 x 1,5 (2 glands, 1 of them with plug and 1 screw plug)

LOOP-IN/OUT possible, for some versions temperature resistant cable is required

Through wiring system: 5 x 2,5mm² through wiring or preparation for 5-pole LOOP-IN/OUT at extra charge

Standard: Facing downwards or forwards

Mounting: Suspension hooks (H8V P) or ceiling brackets (15A P), at extra charge (see accessories)

Attention:

For installation in humid and corrosive atmospheres please select light fittings with housings in stainless steel.

When switched off the light fittings must not be exposed to an a.t. of more than +85°C
Special versions available for extreme conditions (short cycle operation, e.g. rain storage reservoirs or wastewater treatment plants and equivalent) Type E1003 to be selected (please contact us).
Suitable for dry motor vehicle pits only. In case of wall mounting the light fitting must be protected against discharge water.

DB - standardized by Deutsche Bahn AG

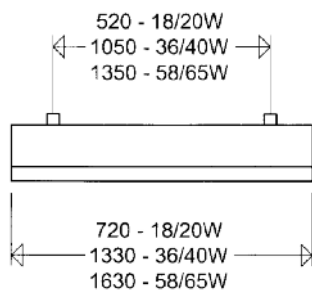

Suspension hooks H8V Ceiling brackets 15A

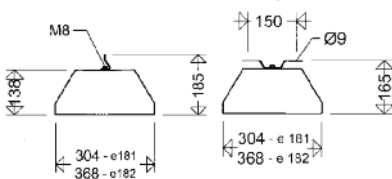

Looping the cable on one side:

All light fittings of series e181/182.. have got 2 cable entries on one small side of the housing for cable looping instead of the through wiring system.

Schuch Quality - your advantage:

- sturdy design of high chemical resistance for application in rough industrial conditions
 - free of paint-wetting impairment substances (silicone-free)
 - reliable, fail-safe and long-life thanks to a special ex-protected quartz sand encapsulated ECG with high-grade quality features:
 - "end-of-life switching-off system" i.e. at the end of its life a fluorescent tube is safely switched off (worldwide first certification acc. to the latest IEC standards IEC 60079-7 with 2 safety circuits test 1 and test 2)
 - in compliance with the requirements of over voltage category III (standard = over voltage category II)
 - widened interference suppression up to 300MHz (standard = 30MHz)
 - double channel system for separate lamp monitoring
 - extremely favourable operating temperatures thanks to a special quartz sand encapsulation inside an aluminium housing are a guarantee for a long life time (up to 100.000h) and a low failure rate
 - best suitable for mounting and maintenance purpose
 - Original SCHUCH central locking system with hinged safety glass pane for an easy lamp replacement
 - easily accessible connection compartment via hinged reflector
 - wide range of application and flexibility at most different environmental conditions
 - certification for installation in gas and dust atmospheres (zones 1 and 21)
 - wide and admissible range of ambient temperature from -20°C to +60°C (version "H")
 - for connection to central- or group battery systems with DC-detection and change-over to 1- lamp operation (emergency mode - types e181/182... ZB)
 - separate frame for recessed installation and a swivel arm mounting system can be installed at a later stage, too (frame for recessed installation not suitable for stainless steel version!).
- A high flexibility of application combined with an economic storing is guaranteed

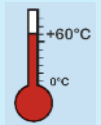

e181..



II 2 G Ex d e q IIC
T4 Gb

II 2 D Ex tb IIIC
T80°C Db



EC-Type Examination Certificate:

IBExU 02 ATEX 1018

TÜV 12 ATEX 097164

Marking:

II 2 G Ex d e q IIC T4 (Zone 1)

II 2 D Ex tb IIIC T80°C Db (Zone 21)

Ignition protection: e (increased safety)

Admissible ambient temperature:

-20°C to +50°C (1 or 2 lamps)

-20°C to +40°C (3 or 4 lamps)

special versions up to +60°C.

Rated voltage: 220-240 V AC/DC, 0 or 50/60 Hz.



Type	Article no.	max. Amb. Temp.	Lamps Watt	Weight ca. kg
narrow housing				
e181 21	18000 0001	60°C	1 x T 26/18 W	11,7
e181 22	18000 0002	60°C	2 x T 26/18 W	11,7
e181 23	18000 0009	60°C	3 x T 26/18 W	13,6
e181 41	18000 0003	60°C	1 x T 26/36 W	17,6
e181 42	18000 0004	60°C	2 x T 26/36 W	19,0
e181 43	18000 0010	55°C	3 x T 26/36 W	22,9
e181 61	18000 0005	55°C	1 x T 26/58 W	22,5
e181 62	18000 0006	55°C	2 x T 26/58 W	22,5
e181 63	18000 0011	50°C	3 x T 26/58 W	24,6

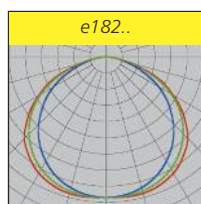



Type	Article no.	max. Amb. Temp.	Lamps Watt	Weight ca. kg
------	-------------	-----------------	------------	---------------

wide housing

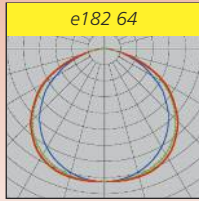

e182 23	18000 0201	55°C	3 x T 26/18 W	14,8
e182 24	18000 0202	55°C	4 x T 26/18 W	14,8
e182 43	18000 0203	60°C	3 x T 26/36 W	22,5
e182 44	18000 0204	55°C	4 x T 26/36 W	22,5
e182 63	18000 0205	50°C	3 x T 26/58 W	27,0
e182 64	18000 0206	40°C	4 x T 26/58 W	27,0

Explosion protected Light Fittings Zone 1



Dimensions for recessed installation

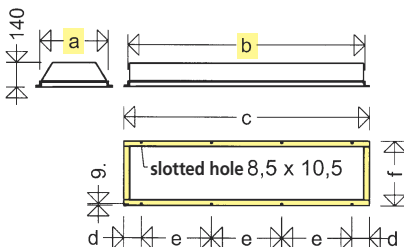

Frame	a	b	c	d	e	f
EB 181/18	324	740	786	93	300	370
EB 181/36	324	1350	1396	98	400	370
EB 181/58	324	1650	1696	48	400	370
EB 182/18	388	740	786	93	300	434
EB 182/36	388	1350	1396	98	400	434
EB 182/58	388	1650	1696	48	400	434

Attention: For recessed installation the length of the cable glands must be considered!

Frame for Recessed installation

retrofit possible!

Light fittings of series e181../e182.. may be equipped with a separate frame even at a later stage. Also suitable for clean areas (not suitable for stainless steel ver-

sion).

This frame is mounted to the long sides of the housing by means of bolts of size M5 (see drawing).

Type	Article no.	Description
EB 181/18	18091 0001	frame for narrow housing, 1,2 and 3 x 18 W
EB 181/36	18091 0002	frame for narrow housing, 1,2 and 3 x 36 W
EB 181/58	18091 0003	frame for narrow housing, 1,2 and 3 x 58 W
EB 182/18	18091 0004	frame for wide housing, 3 and 4 x 18 W
EB 182/36	18091 0005	frame for wide housing, 3 and 4 x 36 W
EB 182/58	18091 0006	frame for wide housing, 3 and 4 x 58 W

Swivel Arm Mounting System

retrofit possible!

Light fittings of series e181../e182.. may be equipped with a swivel arm mounting system at any time even at a later stage.

The swivel arms are fixed to the suspension points at the upper side of the housing. Swivel range: $\pm 75^\circ$ (see dimensions in diagram).

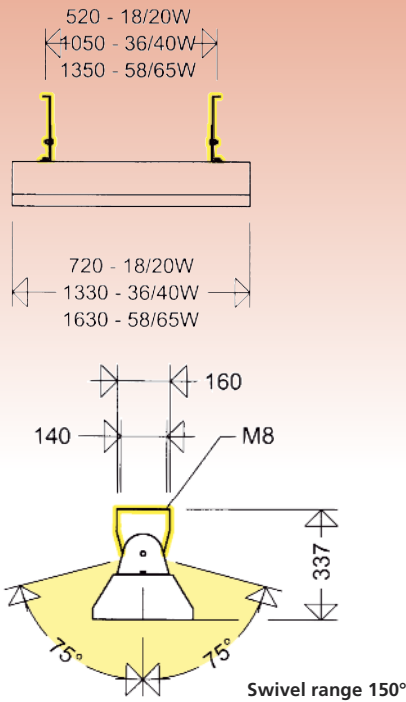

Type	Article no.
SWA 181/182	18092 0001 for all types, comprising 2 swivel arms with bolts M8



Further Series / Equipment

- with monitoring module for individual monitoring the light fitting connected to a central or group battery system
- housing made from stainless steel – painted
- up to 4 cable entries
- different glands
- through wiring system up to 5 x 6,0mm²
- for 5-core cable looping system
- for connection to central- or group battery system with DC-detection and change-over to 1-lamp operation (emergency mode - types e181/182 ... ZB)
- without isolating switch (types e181/182.. OS)
- for very dusty areas of zones 21 and 22 (series e187/188..) and (series nD187/188..)
- zone 2/22 version (series n/nD 181/182..)
- non-explosion-protected versions (series 181/182...) as dust- and waterproof version

Mounting material

Suspension hooks H8V P

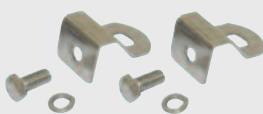

Ceiling brackets 15A P



Wall angle WD 45 P



Further accessories such as carrier rail systems and through wiring systems are available.

Accessories / Spare Parts

Type	Article no.	
Spare glass panes		
181 18-1	18090 9001	for narrow housings, 1, 2 und 3 x 18 W
181 36-1	18090 9002	for narrow housings, 1, 2 und 3 x 36 W
181 58-1	18090 9003	for narrow housings, 1, 2 und 3 x 58 W
182 18-1	18090 9004	for wide housings, 3 und 4 x 18 W
182 36-1	18090 9005	for wide housings, 3 und 4 x 36 W
182 58-1	18090 9006	for wide housings, 3 und 4 x 58 W
Cable entries/glands		
2537 G	90117 9006	ex-protected gland of size M25 x 1,5 with nut
2539 G	90119 9001	ex-protected gland of size M25 x 1,5 with nut and with plug
2538 G	90118 9006	ex-protected plug of size M25 x 1,5 with nut
Lamp holders		
e8911 P	90189 9011	1 pair of turn-latch lamp holders for fittings manufactured from 09/2009
Mounting material		
H8V P	90001 0002	2 suspension hooks with bold M8, stainless steel
15A P	90000 0002	2 ceiling brackets, steel hot galvanized
15AV P	90032 0002	2 ceiling brackets, stainless steel
WD 45 P	26000 0005	2 wall/ceiling angle, steel